



TASK

# STANDARDS

TEMPORARY CONSTRUCTION SIGNAGE

VOLUME 10 TERMINALS

PROJECT N° FC-7744

 Hartsfield-Jackson  
Atlanta International Airport®

Prepared by: **ATLNEXT** |  VALANCOURT  
INTERNATIONAL, LLC

**1.0**

TEMPORARY CONSTRUCTION SIGNAGE  
**GRAPHIC STANDARDS**

VOLUME **1.0** TERMINALS

- 1.1 Typography
- 1.2 Terminology / Symbology
- 1.3 Icons / Logos
- 1.4 Color Palette
- 1.5 Arrows

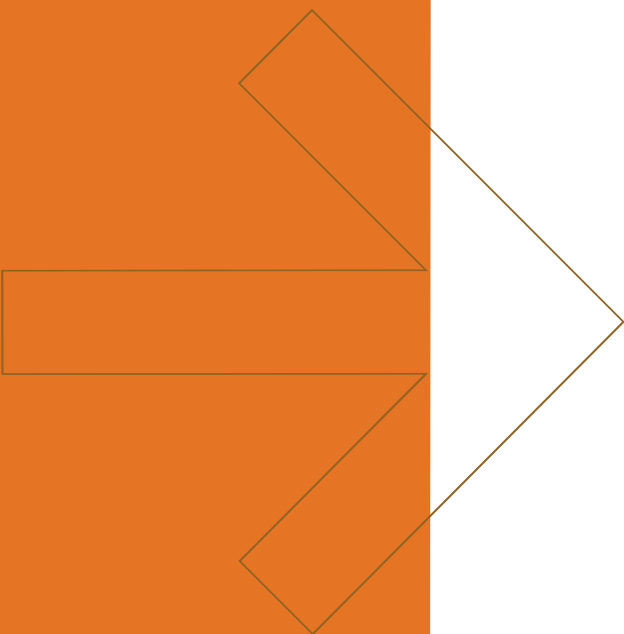

1.0 GRAPHIC STANDARDS

- 1.1 Typography ..... 1-01
  - Standard Font ..... 1-01
  - Letter Spacing ..... 1-01
  - Line Spacing ..... 1-01
  - Arrow / Symbols / Message Spacing ..... 1-01
  
- 1.2 Terminology / Symbology
  - Principal Facilities ..... 1-02
  - Primary Functions ..... 1-02
  - Secondary Functions ... 1-02
  - Building Circulation ..... 1-02
  - Services ..... 1-02
  
- 1.3 Color Standards
  - Primary - Message Panel (Symbology, Arrow Panels) ..... 1-03
  - Secondary (Graphics Elements) ..... 1-03

A B C D E F G H I J K L M N O P Q R S T U V W X Y Z  
 a b c d e f g h i j k l m n o p q r s t u v w x y z  
 0 1 2 3 4 5 6 7 8 9 @ # \$ % ^ & \* ( ) : ;

1.1-1 Gotham Book



Letter Spacing Example

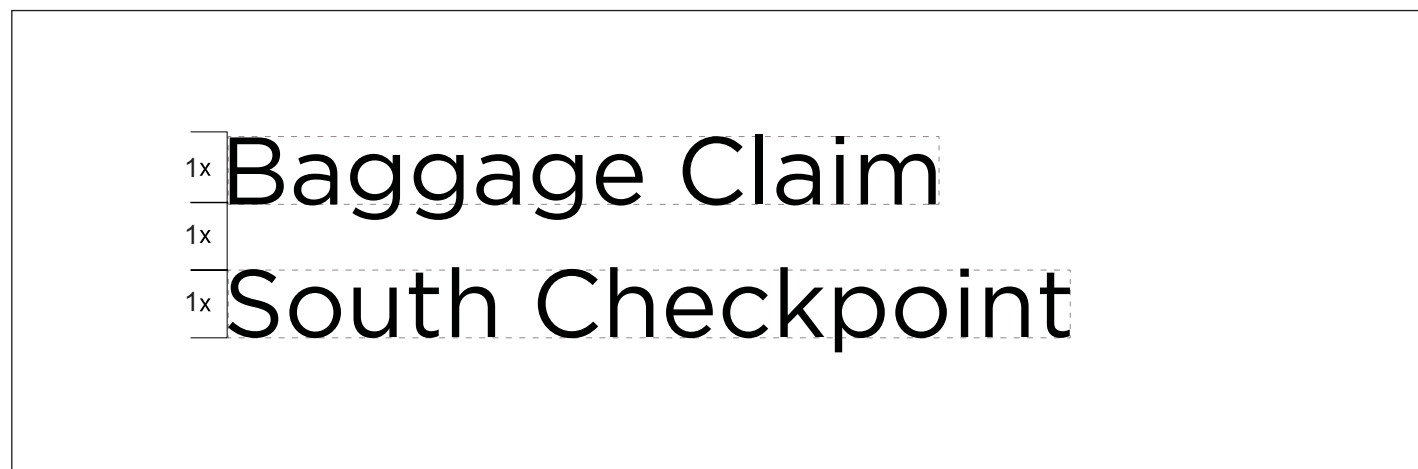

Line Spacing Example - Unrelated Messages



Line Spacing Example - Related Messages



Symbol / Message Spacing Example



Arrow / Symbols / Message Spacing Example

1.1-2 Letter Spacing / Line Spacing

1.1-3 Line Spacing



Principal Facilities

NOMENCLATURE	SYMBOL
Terminal South	
Terminal North	

Primary Functions

TERMINOLOGY	SYMBOL
Ticketing / Check-In	
Baggage Claim	
Main Checkpoint	
North Checkpoint	
South Checkpoint	
Ground Transportation	
Arrivals Lobby	
Passenger Pick-Up	
Parking	
North Parking	
South Parking	
ATL West Parking	
Rental Car Center	

Secondary Function

SECONDARY TERMINOLOGY	SYMBOL
Rideshare	
MARTA	
Greyhound Link	
TSA Pre-Check*	
Clear*	

\*Obtain official symbols from the Department of Aviation

Building Circulation

SECONDARY TERMINOLOGY	SYMBOL
Elevator	
Escalator - Up	
Escalator - Down	
Stairs	
Emergency Stairs	

Services

SECONDARY TERMINOLOGY	SYMBOL
Restrooms	
Mens Restroom	
Women Restroom	
Family Restroom	
Information	
Lost & Found	

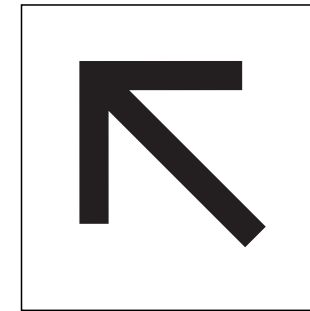

Up to the Left  
10 o'clock

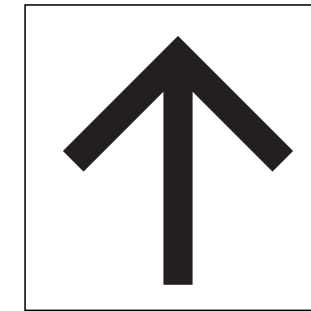

Up and/or Straight  
Ahead / 12 o'clock

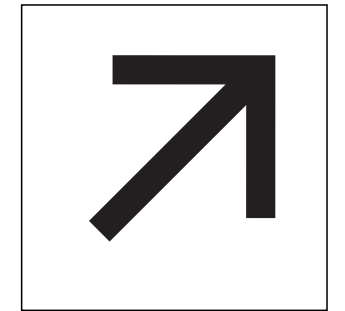

Up to the Right  
2 o'clock

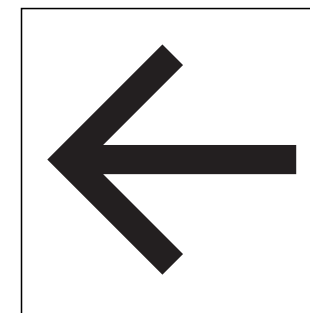

To the left  
9 o'clock

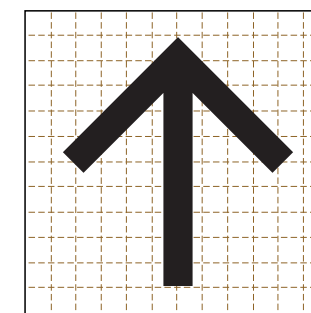

To the Right  
3 o'clock

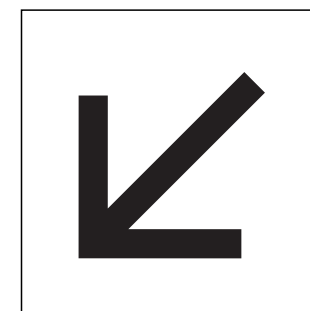
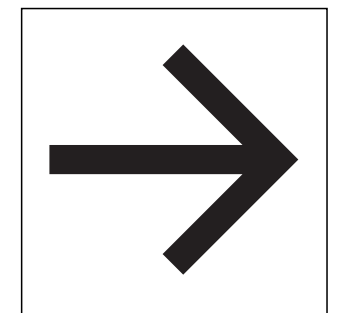

Down to the Left  
7 o'clock

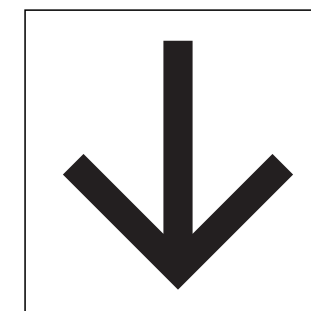

Down  
6 o'clock

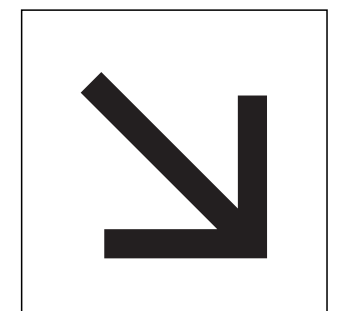

Down to the Right  
5 o'clock

1.2-1 Terminology / Symbology

1.2-2 Arrow Standards

PRIMARY:

-  Sign Background  
**Pantone 152**
-  Message / Symbol  
**Pantone Black**

See fig. 1.3-2

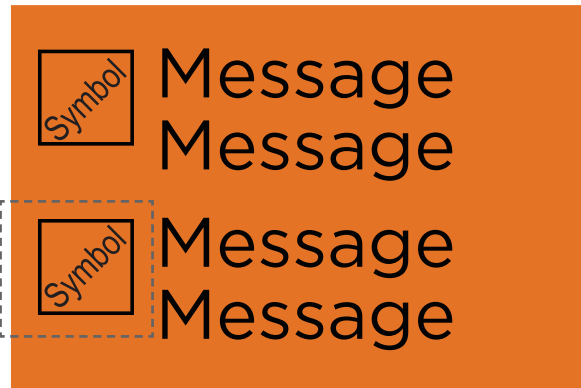

1.3-1 Color Standards (Primary): Message panel

-  Symbol Background  
**Pantone 152**
-  International Symbols  
**Pantone Black**



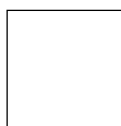

1.3-2 Color Standards (Primary): International Symbol

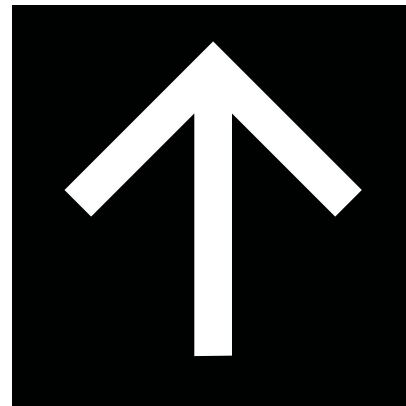
-  Arrow Panel Background  
**Pantone Black**
-  Arrow Symbol  
**White (Opaque)**



1.3-3 Color Standards (Primary): Arrow Panel / Arrow Symbol

SECONDARY:

-  Line Work / Copy  
**Pantone 152**
-  Background  
**Pantone Black**

Obtain high resolution artwork from the Department of Aviation

1.3-4 Color Standards (Secondary): "Detour" Stamp





-  ATL/Airplane Symbol  
**Pantone Cool Gray 5C**
-  NET  
**Pantone Cool Gray 8C**



1.3-5 Color Standards (Secondary): Logo / Icon

Obtain high resolution artwork from the Department of Aviation

-  Sign Background  
**Pantone 152**
-  Stripping (Chevron)  
**Pantone Black**



1.3-6 Color Standards (Secondary): "Chevron" Stripping

QR Code to be developed by the Client.



1.3-7 Color Standards (Secondary): QR Code

**2.0**

TEMPORARY CONSTRUCTION SIGNAGE  
**SIGN TYPES**

- 2.1 Sign Type Series Number
- 2.2 Sign Type Identification System
- 2.3 Sign Type Layouts

VOLUME **10** TERMINALS



2.0 SIGN TYPES

2.1 Sign Type Series Number ..... 2-01

2.2 Sign Type Identification System ..... 2-02

2.3 Sign Type Layouts

ST-800 Directional (Primary) : Freestanding ..... 2-02

ST-802 Directional (Primary) : Trailblazer (Freestanding) ..... 2-03

ST-804 Directional (Primary) : Trailblazer (Surface Application) ..... 2-04

ST-806 Directional (Primary) : Trailblazer (Surface Application) ..... 2-05

ST-810 Directional (Secondary) : 2 Levels / 2 Directional ..... 2-06

ST-812 Directional (Secondary) : 2 Levels / 1 Directional ..... 2-07

ST-814 Directional (Secondary) : 1 Level / 2 Directional ..... 2-08

ST-816 Directional (Secondary) : 1 Level / 1 Directional ..... 2-09

ST- 830 Informational (Primary) : Freestanding / Directory ..... 2-10

Project:



HARTSFIELD-JACKSON ATLANTA INTERNATIONAL AIRPORT  
Temporary Construction Signage

Document Title:

Task 2.2 - STANDARDS :  
Temporary Construction Signage

Project: FC - 7744

Issued as: **Final** ..... Date: **February 22, 2022**

REV. February 22, 2022  
REV. July 15, 2022  
REV.

REV.   
REV.

Prepared by:



**VOLUME 1.0**  
**TERMINALS**

Table of Contents

PAGE

T.O.C



2.1 Sign Type Series Number

INTERIOR SIGN TYPES:

Terminals ( Domestic / International)

- 800 - 819 – Directional
- 820 - 829 – Identification
- 830 - 839 – Informational

Concourses (T,A,B,C,D,E,F)

- 840 - 849 – Directional
- 850 - 859 – Identification
- 860 - 869 – Informational

Transportation Mall (T,A,B,C,D,E,F)

- 870 - 879 – Directional
- 880 - 889 – Identification
- 890 - 899 – Informational

EXTERIOR SIGN TYPES:

Curbsides / Ground Transportation (Domestic / International)

- 900 - 919 – Directional
- 920 - 929 – Identification
- 930 - 939 – Informational

Parking (Domestic / International)

- 940 - 949 – Directional
- 950 - 959 – Identification
- 960 - 969 – Informational

Roadways (Domestic / International)

- 970 - 979 – Directional
- 980 - 989 – Identification
- 990 - 999 – Informational

2.2 Sign Type Identification System

Sign Location Indicator

2.2 - 1 Sign Location Indicator

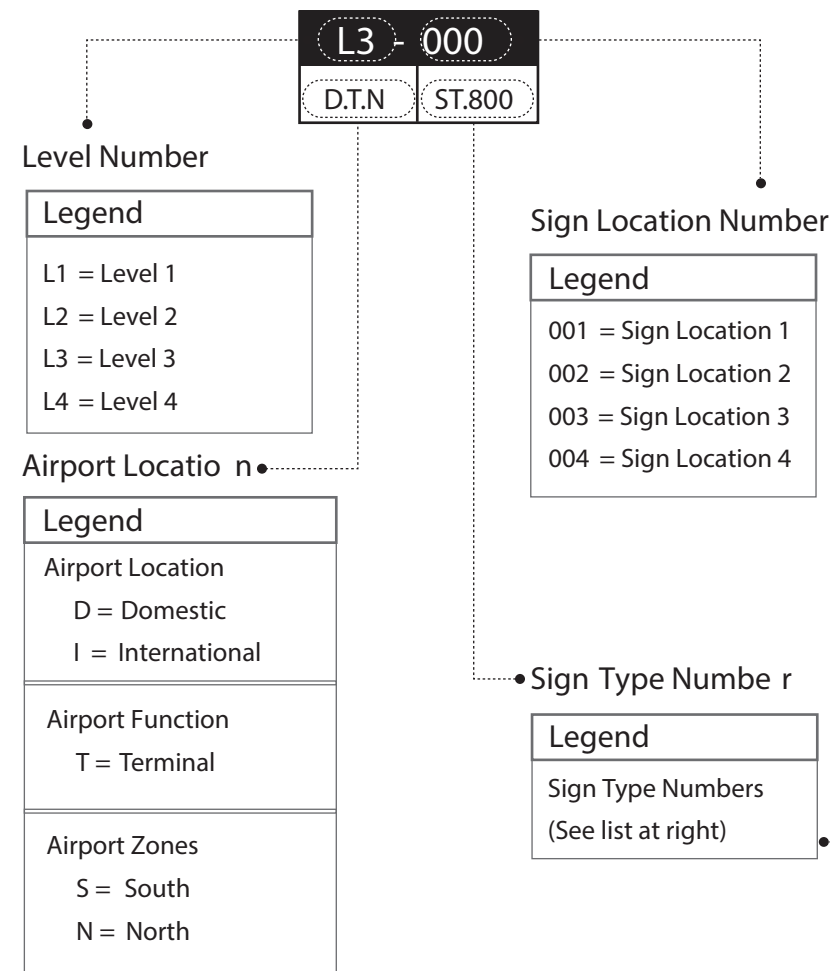

Sign Type Series Numbers

2.2 - 2 Sign Type Series Numbers - Temporary Construction Signage

800 Series – Temporary Signage (Domestic / International)

INTERIOR SIGN TYPES:

Terminals ( Domestic / International)

- 800 - 819 – Directional
- 820 - 829 – Identification
- 830 - 839 – Informational

Concourses (T,A,B,C,D,E,F)

- 840 - 849 – Directional
- 850 - 859 – Identification
- 860 - 869 – Informational

Transportation Mall (T,A,B,C,D,E,F)

- 870 - 879 – Directional
- 880 - 889 – Identification
- 890 - 899 – Informational

**Descriptions:** Directional - Primary  
2 Directional / 3 Levels of Messaging / 2 Sided

**Dimensions:** 8' - 0" H x 2' - 0" W x 1 - 1/2" D

**Location:** **Domestic Terminal North:** Levels 1, 2, 3  
**Domestic Terminal South:** Levels 1, 2, 3

**Typography:** Section 1.0 - Graphics Standards (p1-01)

**Symbology:** Section 1.0 - Graphics Standards (p1-02)

**Colors:** Section 1.0 - Graphics Standards (p1-03)

**Material:** (Gatorboard) - White

**Base Support:** Section 2.0 - Sign Types

**Graphics:** "Detour" Stamp:  
Section 1.0 - Graphics Standards (p1-03)

"Chevron" Stripping:  
Section 1.0 - Graphics Standards (p1-03)

ATLNEXT logo:  
Section 1.0 - Graphics Standards (p1-03)

QR Code:  
Section 1.0 - Graphics Standards (p1-03)

**Mounting:** Freestanding

**Illuminations:** N/A

**Application:** Removable

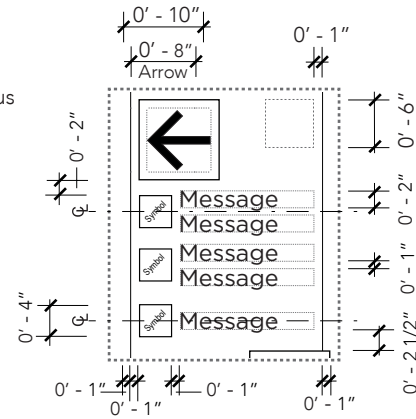
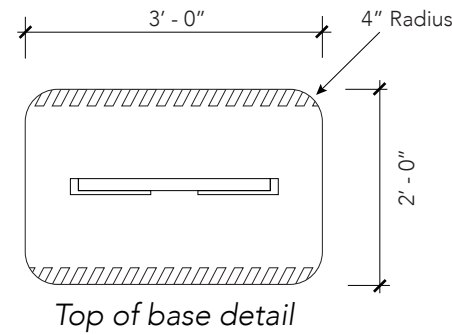

Notes:  
a. 2 lines of related messaging. They are considered to be a single unit. The center line of the message is the spacing between the copies.  
b. 1 line of messaging. The center line is the cap height of the copy itself.

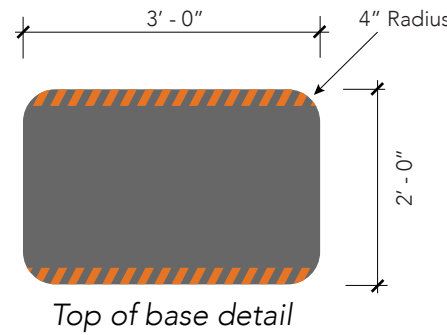

1 PLAN  
SCALE: 1/2" = 1' - 0"

3 DETAIL  
SCALE: 1/2" = 1' - 0"

5 FINISH - PLAN  
SCALE: 1/2" = 1' - 0"

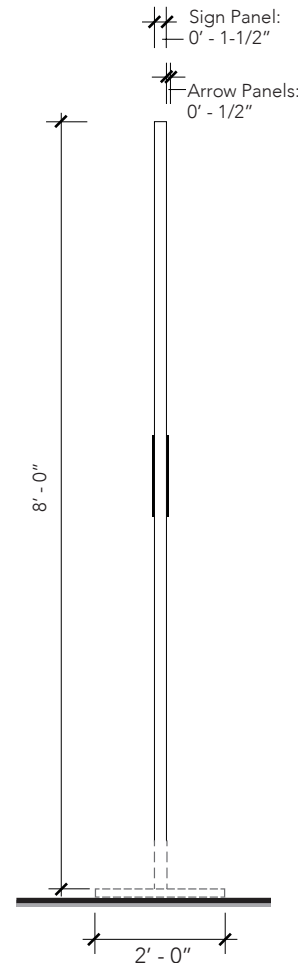
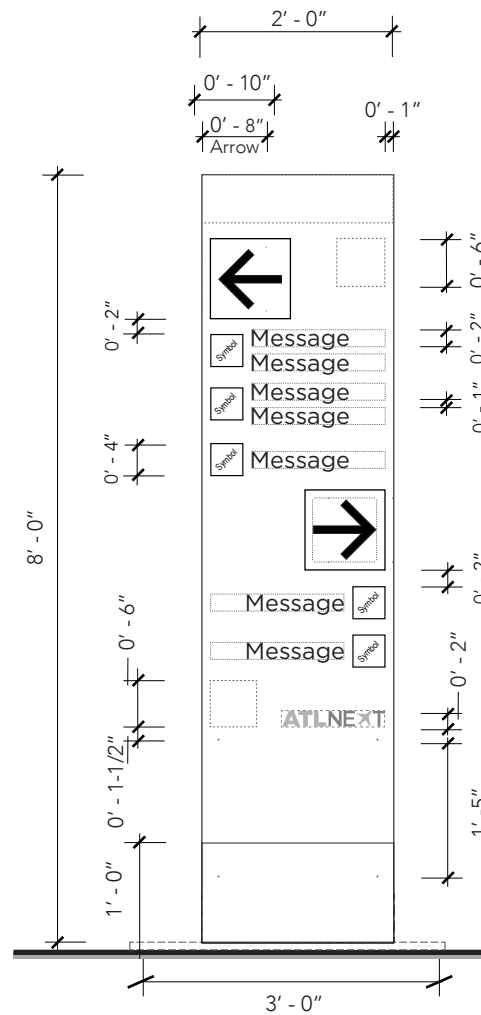

Note: QR Code to be obtained by the Client.

7 FINISH - PROFILE  
SCALE: 1/2" = 1' - 0"

**Descriptions:** Directional - Primary  
Trailblazer  
1 Directional / 1 Level of Messaging / 2 Sided

**Dimensions:** 8' - 0" H x 1' - 0" W x 1 - 1/2" D

**Location:** **Domestic Terminal North:** Levels 1, 2, 3  
**Domestic Terminal South:** Levels 1, 2, 3

**Typography:** Section 1.0 - Graphics Standards (p1-01)

**Symbology:** Section 1.0 - Graphics Standards (p1-02)

**Colors:** Section 1.0 - Graphics Standards (p1-03)

**Material:** (Gatorboard) - White

**Base Support:** Section 2.0 - Sign Types

**Graphics:** "Detour" Stamp:  
Section 1.0 - Graphics Standards (p1-03)

"Chevron" Stripping:  
Section 1.0 - Graphics Standards (p1-03)

ATLNEXT logo:  
Section 1.0 - Graphics Standards (p1-03)

QR Code:  
Section 1.0 - Graphics Standards (p1-03)

**Mounting:** Freestanding

**Illuminations:** N/A

**Application:** Removable

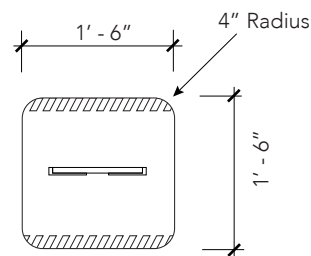

**1 PLAN**  
SCALE: 1/2" = 1' - 0"

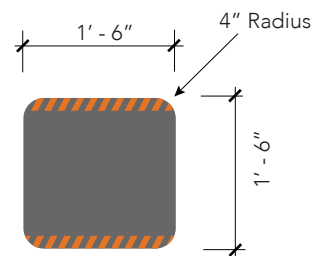

**3 FINISH - PLAN**  
SCALE: 1/2" = 1' - 0"

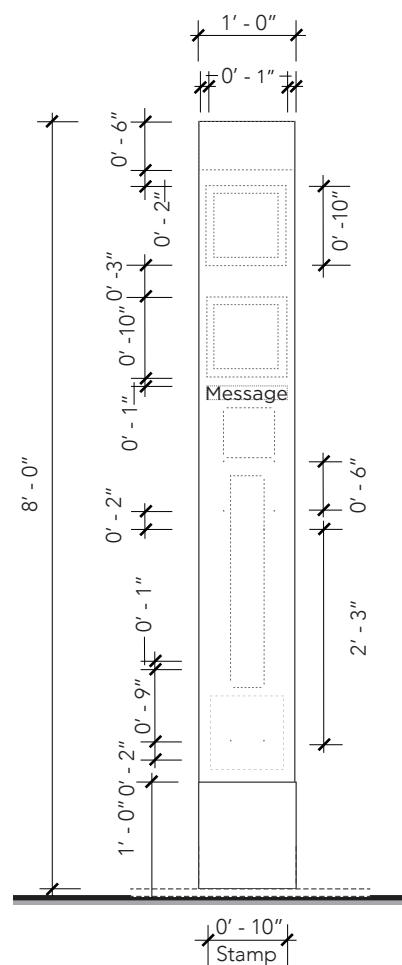

**2 FRONT - SIDE A**  
SCALE: 1/2" = 1' - 0"

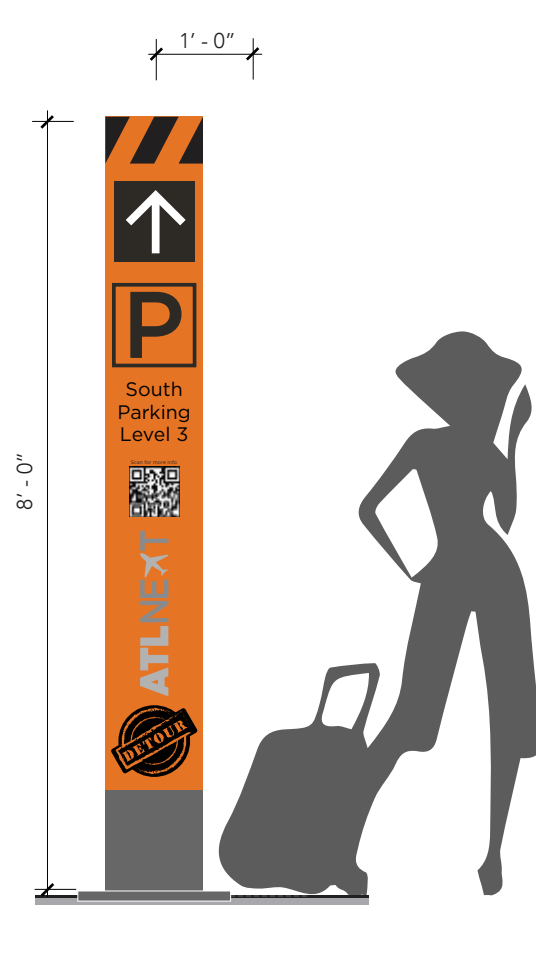

**4 FINISH - ELEVATION SIDE A**  
SCALE: 1/2" = 1' - 0"

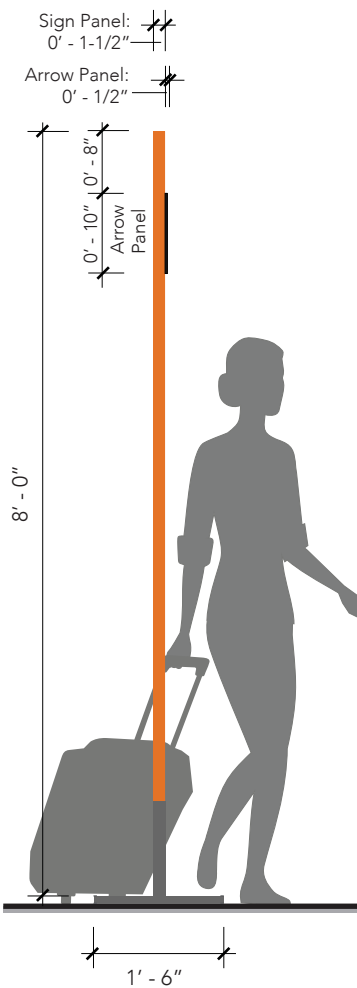

**5 FINISH - PROFILE**  
SCALE: 1/2" = 1' - 0"

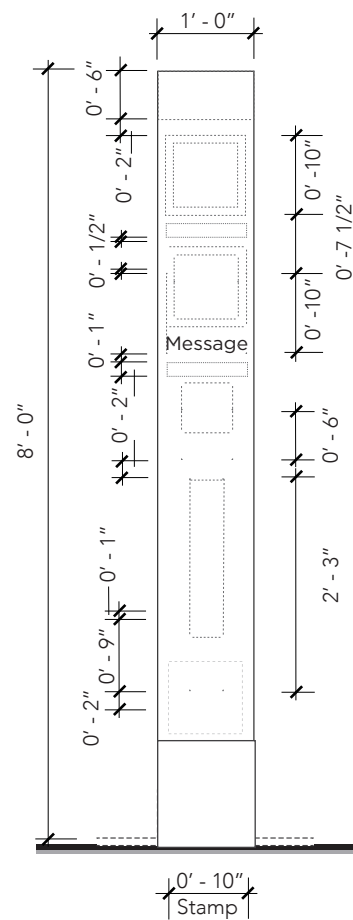

**6 FRONT - SIDE B**  
SCALE: 1/2" = 1' - 0"

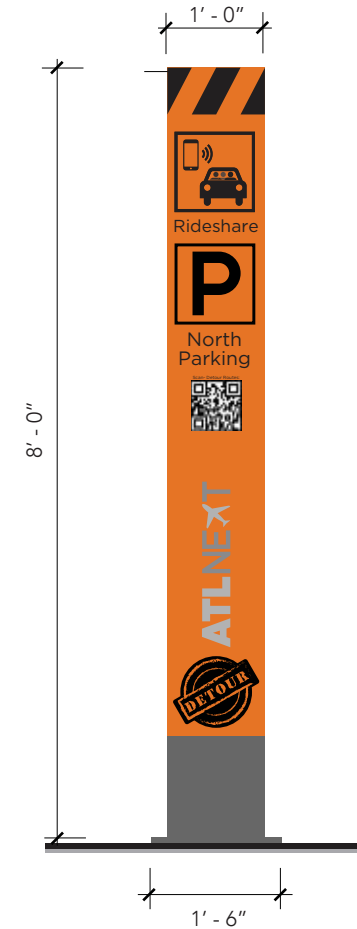

**7 FINISH - ELEVATION SIDE B**  
SCALE: 1/2" = 1' - 0"

Note: QR Code to be obtained by the Client.

**Descriptions:** Directional - Primary  
Trailblazer  
1 Directional / 1 Level of Messaging / 1 Sided

**Dimensions:** 8' - 0" H x 2' - 0" W x 1-1/2" D

**Location:** Domestic Terminal North: Levels 1, 2, 3  
Domestic Terminal South: Levels 1, 2, 3

**Typography:** Section 1.0 - Graphics Standards (p1-01)

**Symbology:** Section 1.0 - Graphics Standards (p1-02)

**Colors:** Section 1.0 - Graphics Standards (p1-03)

**Material:** (Pending)

**Base Support:** N/A

**Graphics:** International Symbol:  
Section 1.0 - Graphics Standards (p1-02)

**Mounting:** Surface

**Illuminations:** N/A

**Application:** Removable Surface Application

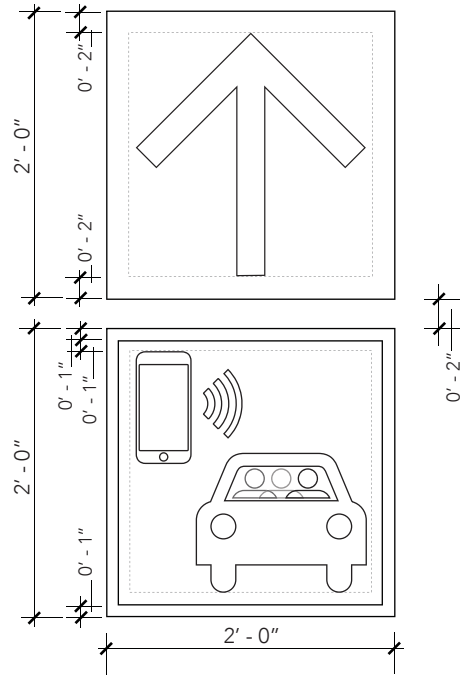

**1 PLAN**  
SCALE: 3/4" = 1' - 0"

Note: Detour Icon artwork to be obtained from DOA.

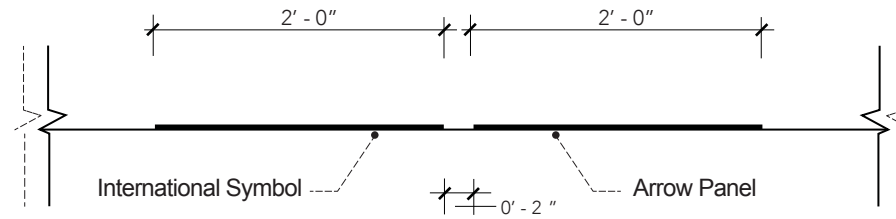

**2 PROFILE**  
SCALE: 3/4" = 1' - 0"

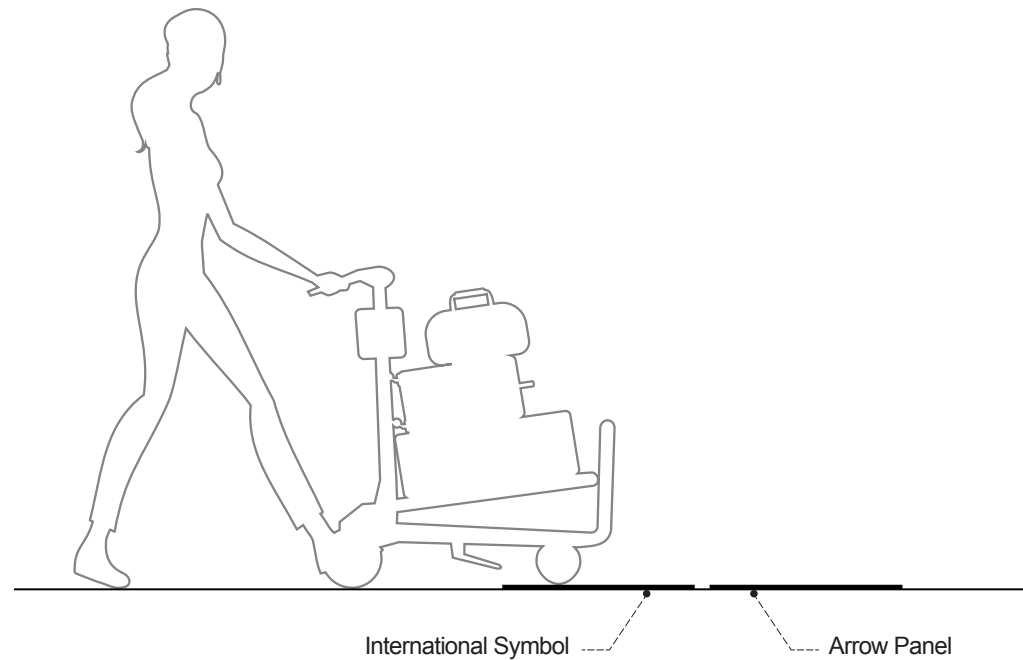

**3 ELEVATION**  
SCALE: 1/2" = 1' - 0"

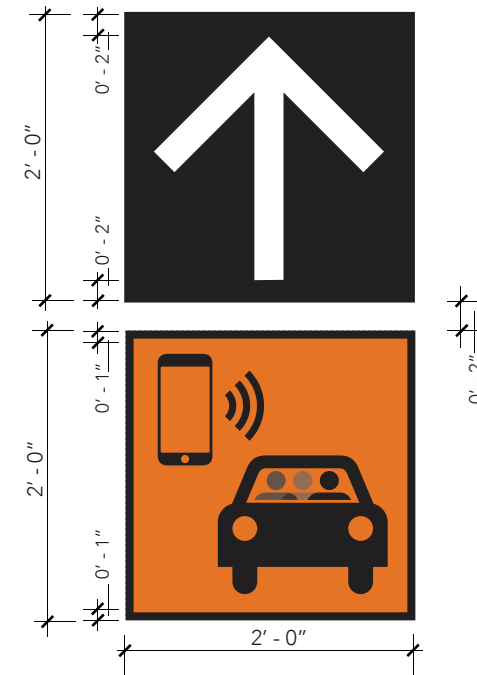

**4 FINISH**  
SCALE: 3/4" = 1' - 0"

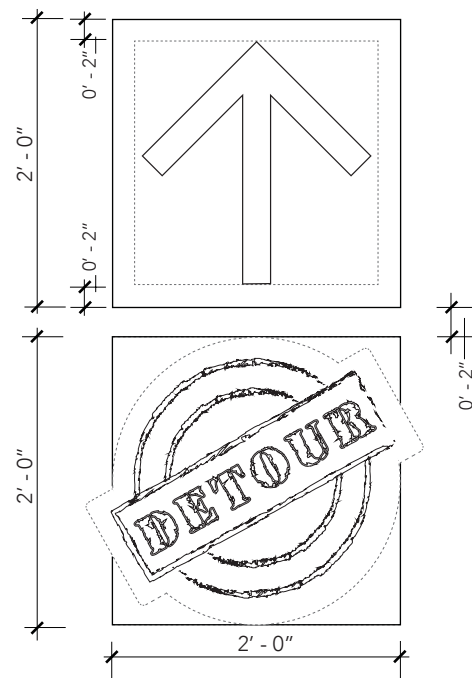

**1** PLAN  
SCALE: 3/4" = 1' - 0"

Note: Detour Icon artwork to be obtained from DOA.

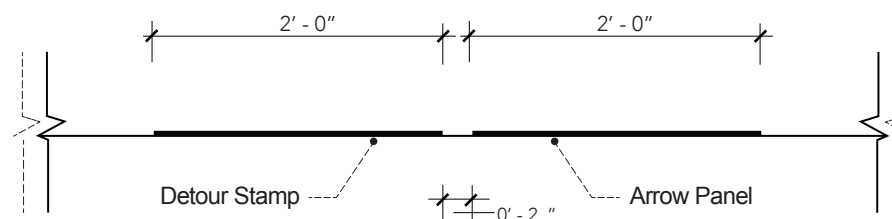

**2** PROFILE  
SCALE: 3/4" = 1' - 0"

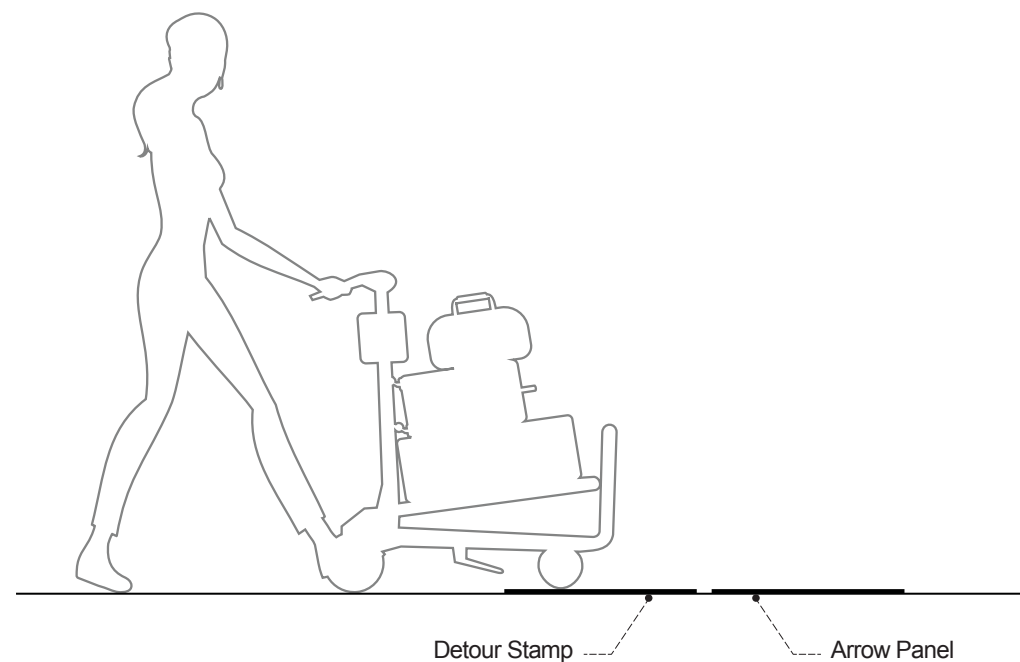

**3** ELEVATION  
SCALE: 1/2" = 1' - 0"

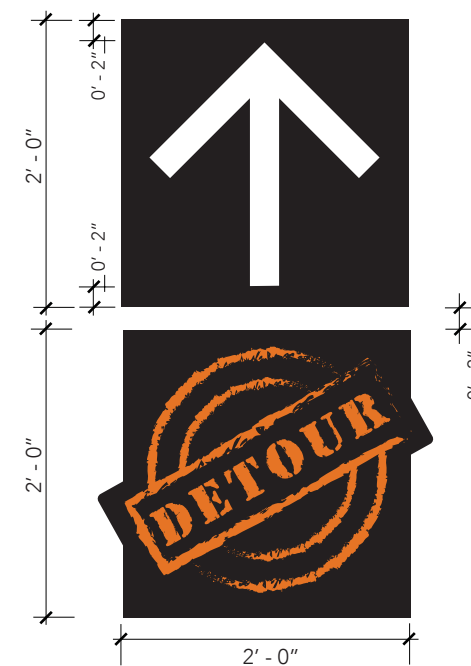

**4** FINISH  
SCALE: 3/4" = 1' - 0"

**Descriptions:** Directional - Primary  
Trailblazer  
1 Directional / 1 Level of Messaging / 1 Sided

**Dimensions:** 8' - 0" H x 2' - 0" W x 1 - 1/2" D

**Location:** Domestic Terminal North: Levels 1, 2, 3  
Domestic Terminal South: Levels 1, 2, 3

**Typography:** Section 1.0 - Graphics Standards (p1-01)

**Symbology:** Section 1.0 - Graphics Standards (p1-02)

**Colors:** Section 1.0 - Graphics Standards (p1-03)

**Material:** (Pending)

**Base Support:** N/A

**Graphics:** "Detour" Stamp:  
Section 1.0 - Graphics Standards (p1-02)

**Mounting:** Surface

**Illuminations:** N/A

**Application:** Removable Surface Application

**Descriptions:** Directional - Secondary  
2 Directional / 2 Levels of Messaging / 2 Sided

**Dimensions:** 16' - 0" W x 2' - 0" H x 1 - 1/2" D

**Location:** Domestic Terminal North: Levels 1, 2, 3  
Domestic Terminal South: Levels 1, 2, 3

**Typography:** Section 1.0 - Graphics Standards (p1-01)

**Symbology:** Section 1.0 - Graphics Standards (p1-02)

**Colors:** Section 1.0 - Graphics Standards (p1-03)

**Material:** (Gatorboard) - White

**Support:** Satin finish aluminum bracket (top)  
Satin finish aluminum connector (center)

**Graphics:** "Detour" Stamp:  
Section 1.0 - Graphics Standards (p1-03)

"Chevron" Stripping:  
Section 1.0 - Graphics Standards (p1-03)

**Mounting:** Ceiling / Suspended / Soffit

**Illuminations:** N/A

**Application:** N/A

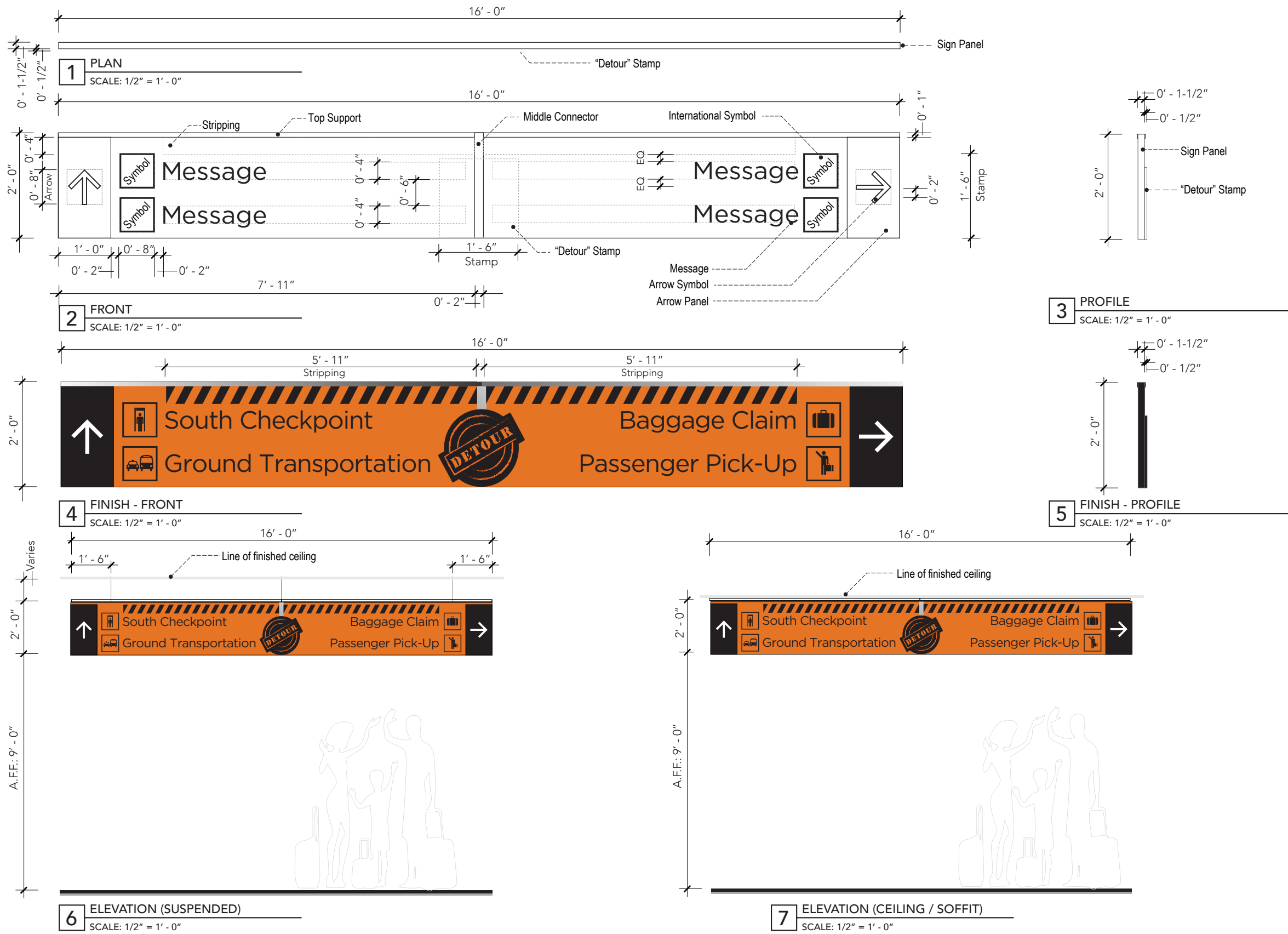

**Descriptions:** Directional - Secondary  
1 Directional / 2 Levels of Messaging / 2 Sided

**Dimensions:** 8' - 0" W x 2' - 0" H x 1-1/2" D

**Location:** **Domestic Terminal North:** Levels 1, 2, 3  
**Domestic Terminal South:** Levels 1, 2, 3

**Typography:** Section 1.0 - Graphics Standards (p1-01)

**Symbology:** Section 1.0 - Graphics Standards (p1-02)

**Colors:** Section 1.0 - Graphics Standards (p1-03)

**Material:** (Gatorboard) - White

**Support:** Satin finish aluminum bracket (top)

**Graphics:** "Detour" Stamp:  
Section 1.0 - Graphics Standards (p1-03)

"Chevron" Stripping:  
Section 1.0 - Graphics Standards (p1-03)

**Mounting:** Ceiling / Suspended / Soffit / Wall

**Illuminations:** N/A

**Application:** N/A

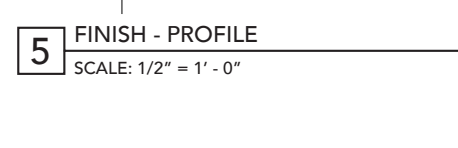
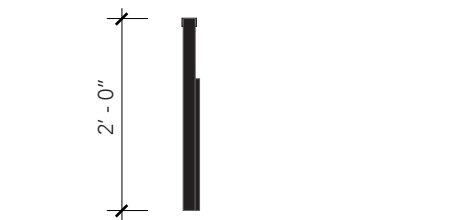
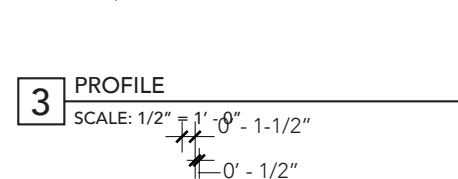
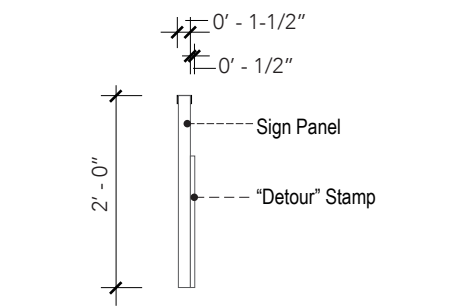
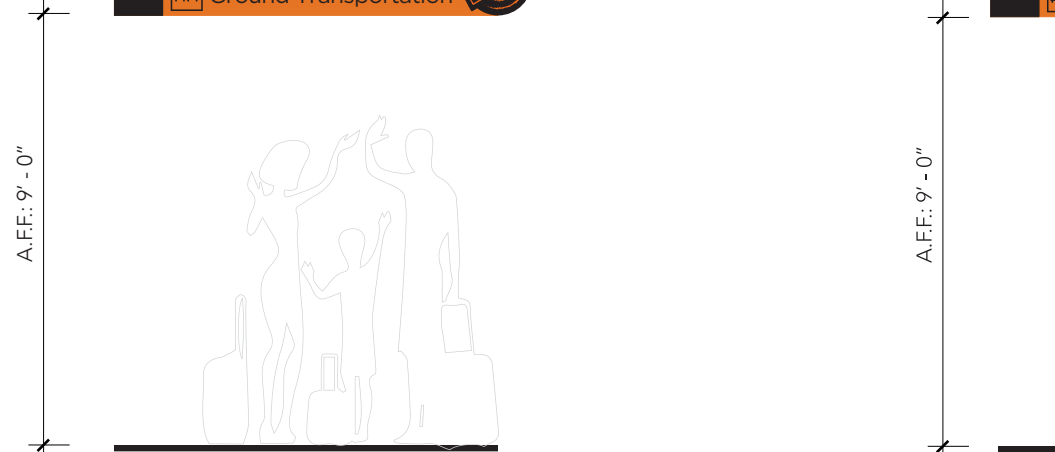
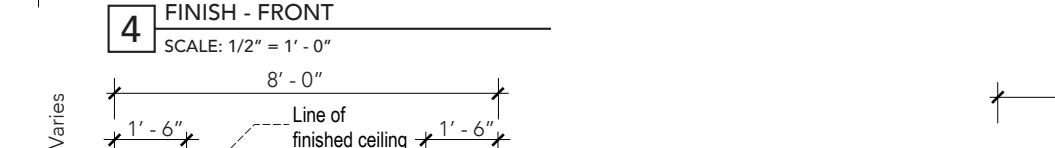
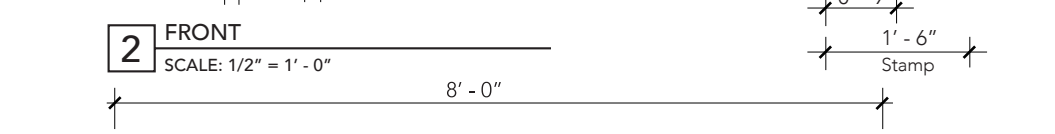
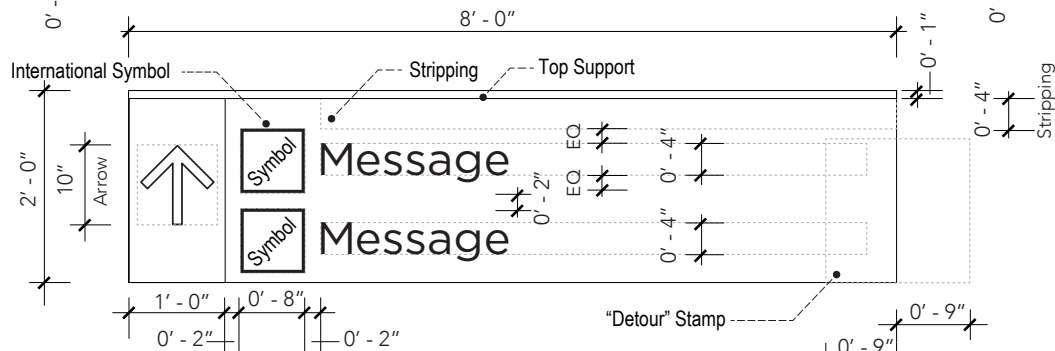
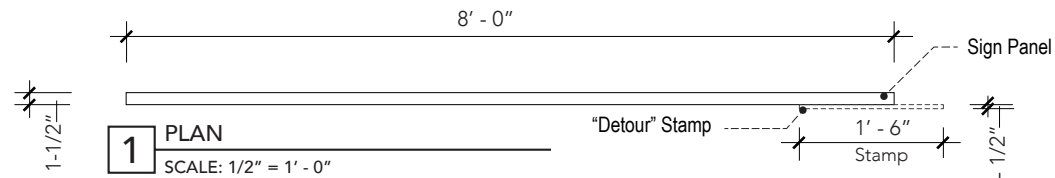

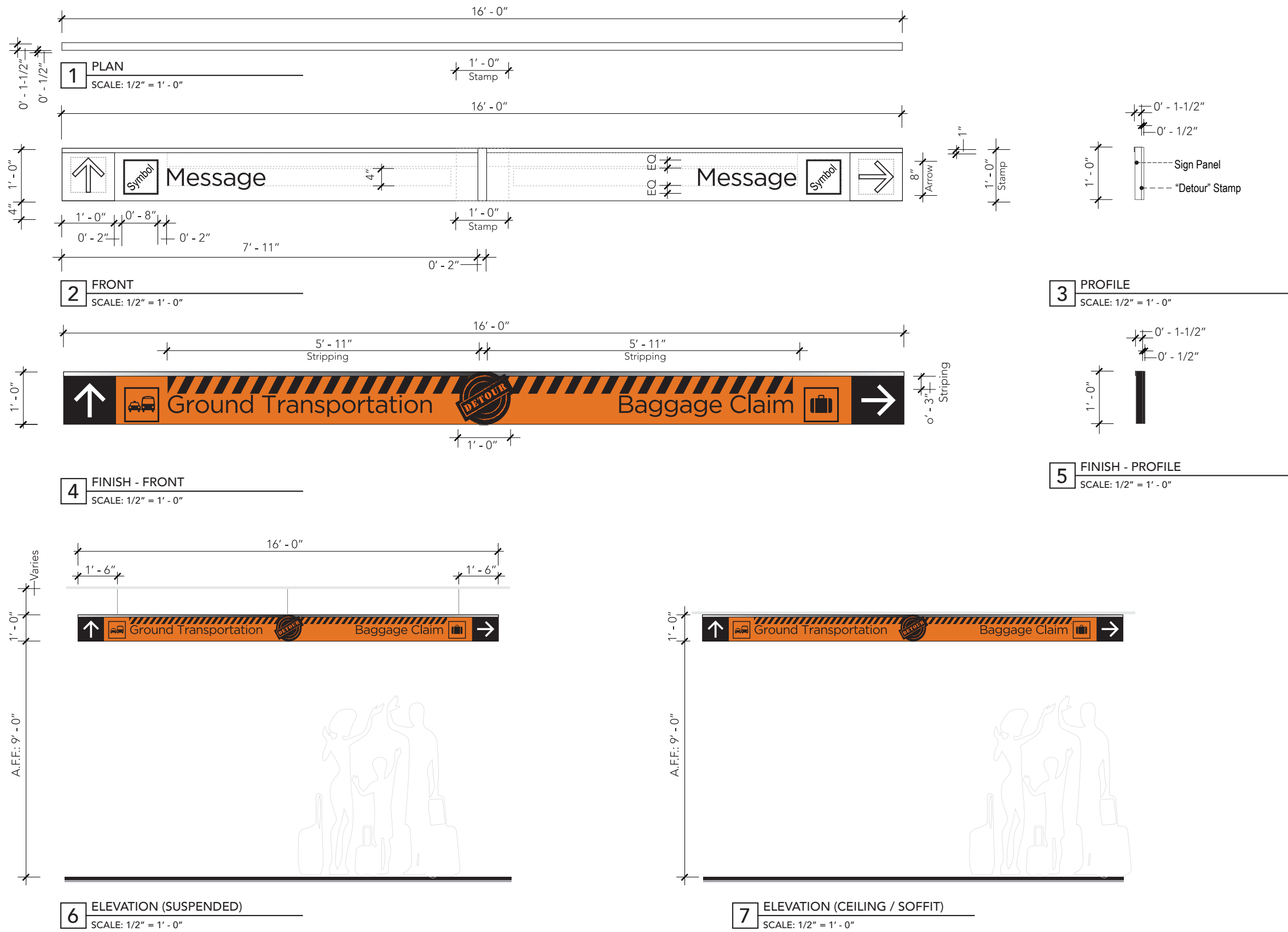

**Descriptions:** Directional - Secondary  
2 Directional / 1 Levels of Messaging / 2 Sided

**Dimensions:** 16' - 0" W x 1' - 0" H x 1 - 1/2" D

**Location:** **Domestic Terminal North:** Levels 1, 2, 3  
**Domestic Terminal South:** Levels 1, 2, 3

**Typography:** Section 1.0 - Graphics Standards (p1-01)

**Symbology:** Section 1.0 - Graphics Standards (p1-02)

**Colors:** Section 1.0 - Graphics Standards (p1-03)

**Material:** (Gatorboard) - White

**Support:** Satin finish aluminum bracket (top)  
Satin finish aluminum bracket (center)

**Graphics:** "Detour" Stamp:  
Section 1.0 - Graphics Standards (p1-03)  
  
"Chevron" Stripping:  
Section 1.0 - Graphics Standards (p1-03)

**Mounting:** Ceiling / Suspended / Soffit

**Illuminations:** N/A

**Application:** N/A



**Descriptions:** Directional - Secondary  
1 Directional / 1 Levels of Messaging / 2 Sided

**Dimensions:** 8' - 0" W x 1' - 0" H x 1 - 1/2" D

**Location:** Domestic Terminal North: Levels 1, 2, 3  
Domestic Terminal South: Levels 1, 2, 3

**Typography:** Section 1.0 - Graphics Standards (p1-01)

**Symbology:** Section 1.0 - Graphics Standards (p1-02)

**Colors:** Section 1.0 - Graphics Standards (p1-03)

**Material:** (Gatorboard) - White

**Support:** Satin finish aluminum bracket (top)

**Graphics:** "Detour" Stamp:  
Section 1.0 - Graphics Standards (p1-03)

"Chevron" Stripping:  
Section 1.0 - Graphics Standards (p1-03)

**Mounting:** Ceiling / Suspended / Soffit / Wall

**Illuminations:** N/A

**Application:** N/A

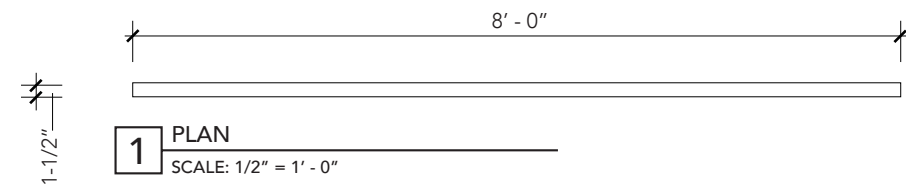

**1 PLAN**  
SCALE: 1/2" = 1' - 0"

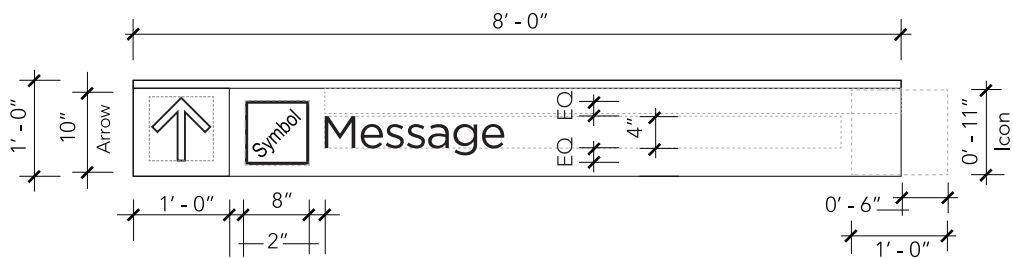

**2 FRONT**  
SCALE: 1/2" = 1' - 0"

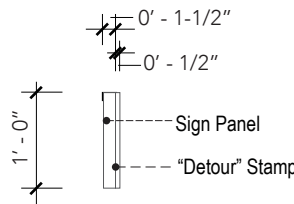

**3 PROFILE**  
SCALE: 1/2" = 1' - 0"

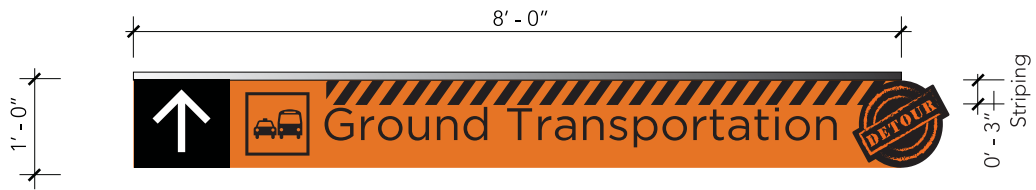

**4 FINISH - FRONT**  
SCALE: 1/2" = 1' - 0"

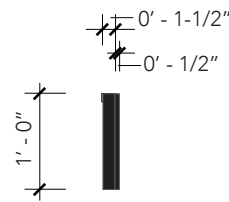

**5 FINISH - PROFILE**  
SCALE: 1/2" = 1' - 0"

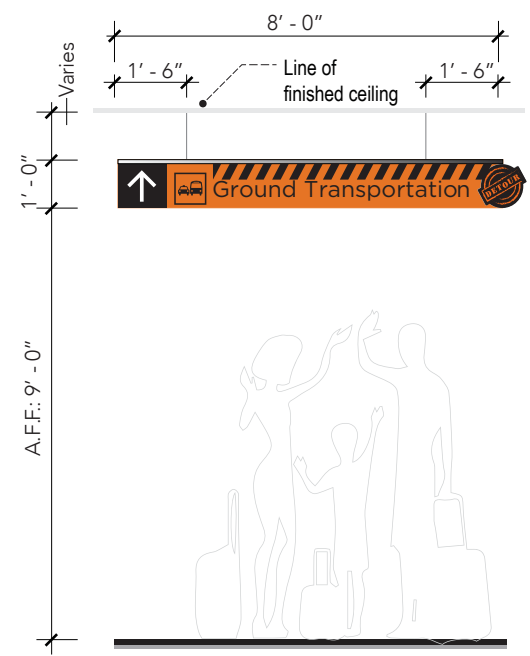

**6 ELEVATION (SUSPENDED)**  
SCALE: 1/2" = 1' - 0"

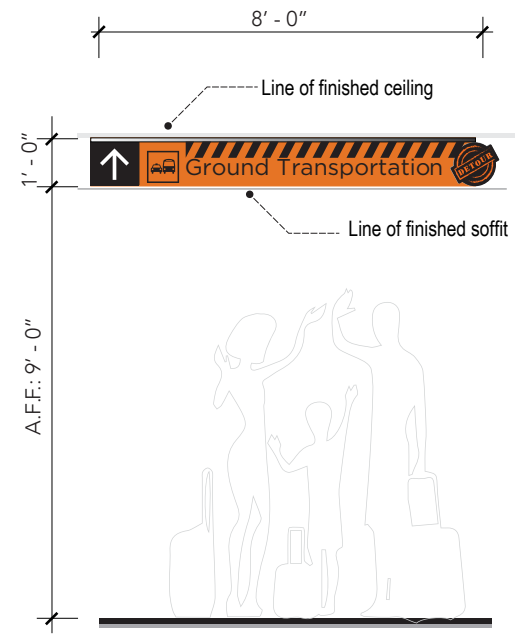

**7 ELEVATION (CEILING / SOFFIT)**  
SCALE: 1/2" = 1' - 0"

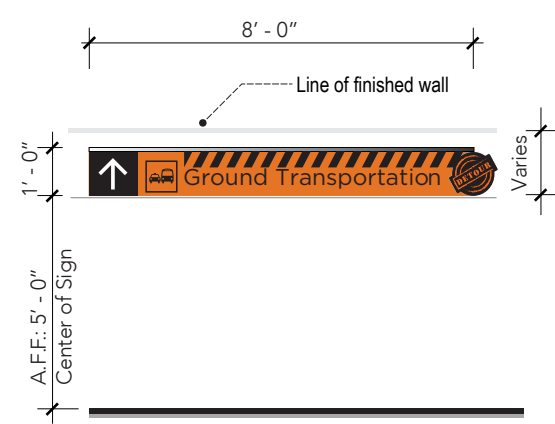

**8 ELEVATION (WALL)**  
SCALE: 1/2" = 1' - 0"

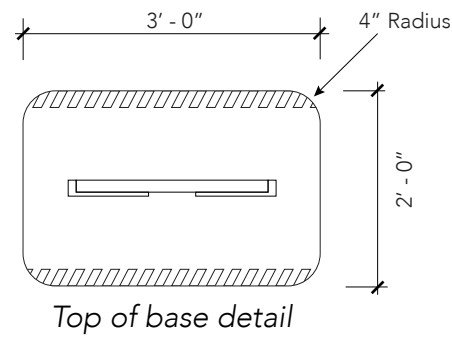

**1** PLAN  
SCALE: 1/2" = 1' - 0"

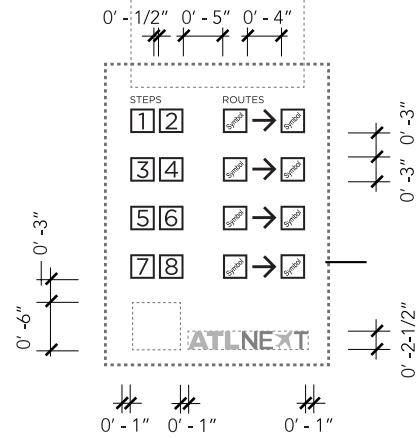

**3** FRONT  
SCALE: 1/2" = 1' - 0"

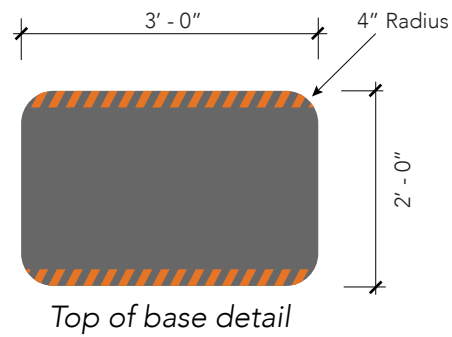

**5** FINISH - PLAN  
SCALE: 1/2" = 1' - 0"

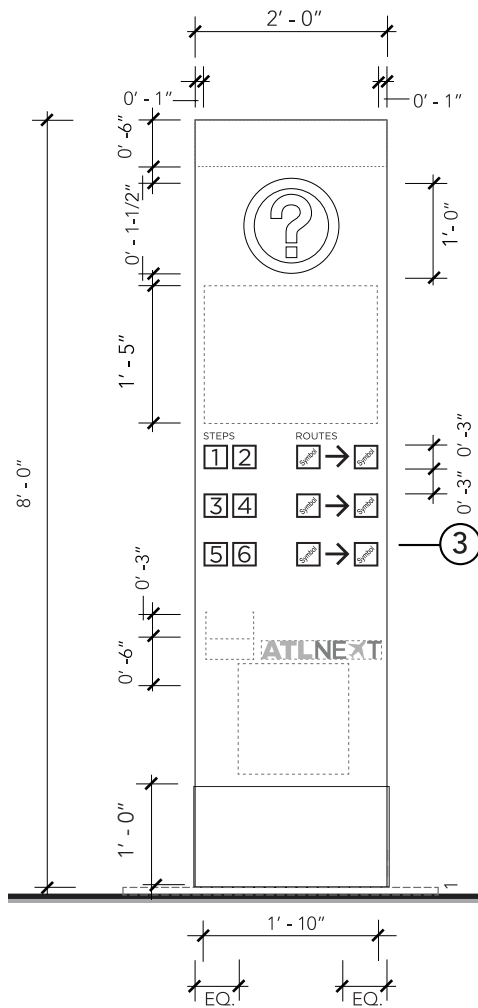

**2** FRONT  
SCALE: 1/2" = 1' - 0"

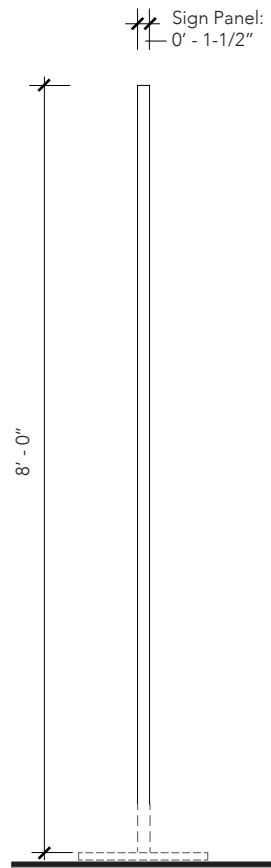

**4** PROFILE  
SCALE: 1/2" = 1' - 0"



Note:  
- Map artwork to be obtained from DOA.  
- QR Code to be obtained by the Client.

**6** FINISH - FRONT  
SCALE: 1/2" = 1' - 0"

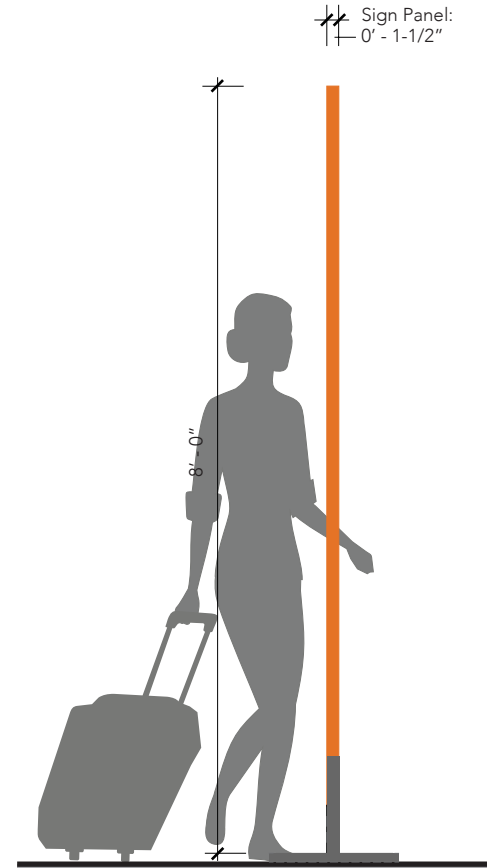

**7** FINISH - PROFILE  
SCALE: 1/2" = 1' - 0"

- Descriptions:** Informational - Primary  
Directory - 2 Sided
- Dimensions:** 8' - 0" H x 2' - 0" W x 1 - 1/2" D
- Location:** **Domestic Terminal North:** Levels 1, 2, 3  
**Domestic Terminal South:** Levels 1, 2, 3
- Typography:** Section 1.0 - Graphics Standards (p1-01)
- Symbology:** Section 1.0 - Graphics Standards (p1-02)
- Colors:** Section 1.0 - Graphics Standards (p1-03)
- Material:** (Gatorboard) - White
- Base Support:** Section 2.0 - Sign Types
- Graphics:** "Detour" Stamp:  
Section 1.0 - Graphics Standards (p1-03)  
  
"Chevron" Stripping:  
Section 1.0 - Graphics Standards (p1-03)  
  
ATLNEXT logo:  
Section 1.0 - Graphics Standards (p1-03)  
  
QR Code:  
Section 1.0 - Graphics Standards (p1-03)
- Mounting:** Freestanding
- Illuminations:** N/A
- Application:** Removable



 **Hartsfield-Jackson**  
Atlanta International Airport.

 **ATLNEXT** |  Viasat.com